



ELLIPTICAL 300 SERIES



- Minimalist Design! Thanks to the extreme simplicity and minimal nature of the fusion line series, it actually works really well as a visual element.
- Reliable safety! Akos Elliptical railings perform extremely well, providing utmost safety and protection.
- Easy & Fast Installation! Elliptical railings are carefully designed to help installers benefit from quick and easy installations at all stages of their placement.



- Combining innovative technologies with special design lines, the Elliptical is the ultimate answer to the demand for contemporary and stylish outdoor spaces such as restaurants, cafes, roof gardens, hotels etc.



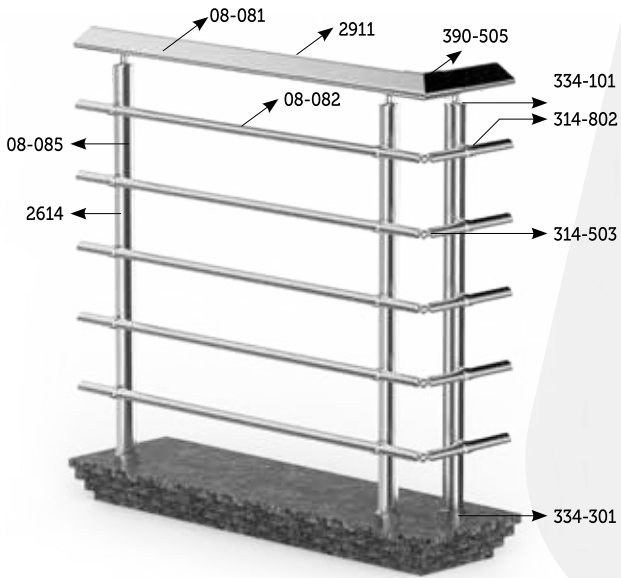

■ Tokyo

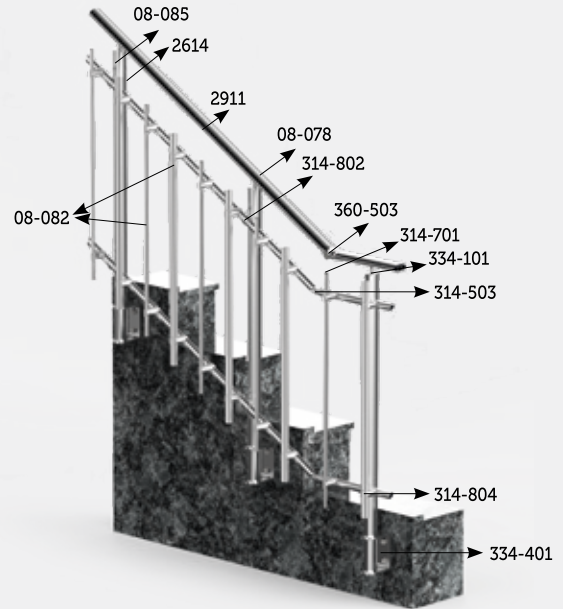

■ Berlin

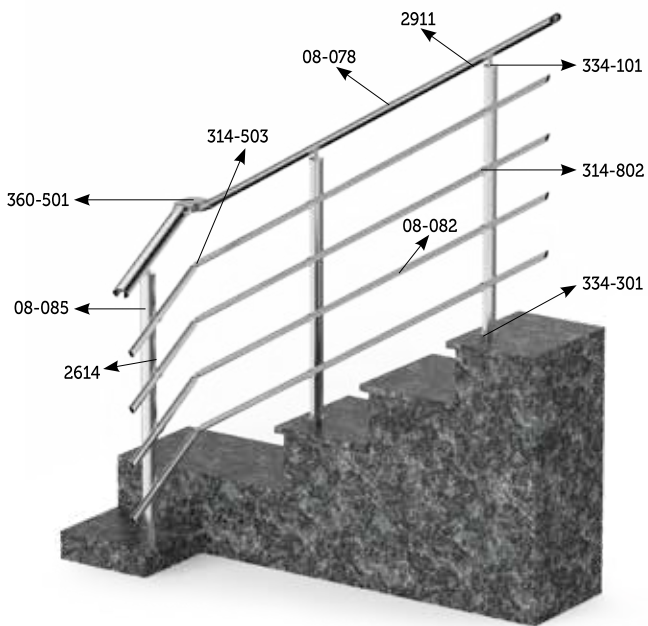

■ Paris



■ Istanbul



■ Dublin



■ Moscow



■ Kabul

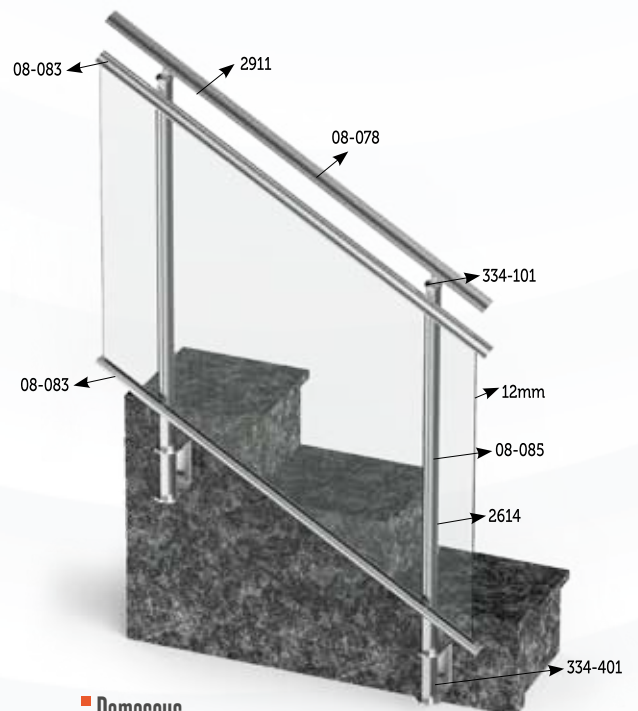

■ Damascus



■ **334-101**
Elliptic Joint Kit



■ **334-103**
Elliptic Corner



■ **334-301**
Elliptic Strut Flange



■ **334-302**
Elliptic U Strut Flange



■ **334-308**
Elliptic Patterned Flange



■ **334-401**
Elliptic Strut Side U
Connector 12 cm



■ **334-701**
Elliptic Strut Plug



■ **300-907**
Elliptic Glass Holder



■ **334-405**
Elliptic Extension
Apparatus



■ **314-701**
Elliptic Plug



■ **314-503**
Elliptic Adjustable Elbow for Barrier



■ **314-804**
Elliptic Double Handle Set

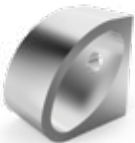

■ **314-802**
Elliptic Pipe Handle



■ **314-601**
Elliptic Pipe Connector



■ **380-701**
Elliptic 80x30 Plug



■ **380-301**
Elliptic 80x30 Wall Flange

ELLIPTICAL SERIES

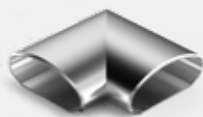

■ **380-511**
Elliptic 80x30 Elbow 90°
(Without Channel)

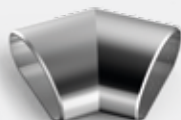

■ **380-512**
Elliptic 80x30 Elbow 45°
(Without Channel)



■ **380-601**
Elliptic 80x30 Ring



■ **390-701**
Elliptic Pear Plug



■ **360-701**
Elliptic 60x25 Plug



■ **360-301**
Elliptic 60x25 Wall Flange



■ **360-501**
Elliptic 60x25 Elbow for
Both Side Moving

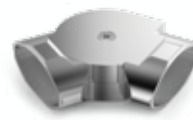

■ **360-504**
Elliptic 60x25 Elbow With Side Moving



■ **360-503**
Elliptic 60x25 Elbow With Vertical
Moving



■ **360-302**
Elliptic 60x25 Elbow for
Wall Connection

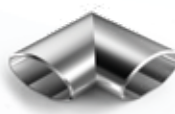

■ **360-511**
Elliptic 60x25
Elbow 90° (Without Channel)

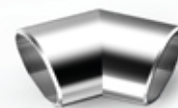

■ **360-512**
Elliptic 60x25 Elbow 45°
(Without Channel)



■ **360-601**
Elliptic 60x25 Ring



■ **330-701**
Elliptic Pipe Plug-Right

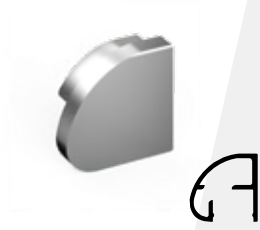

■ **330-702**
Elliptic Pipe Plug-Left

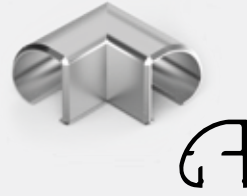

■ **330-501**
Elliptic Glass Holder
Elbow 90° Outer Channel

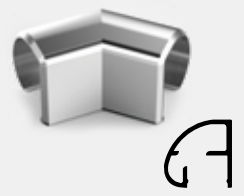

■ **330-503**
Elliptic Glass Holder
Elbow 45° Outer Channel

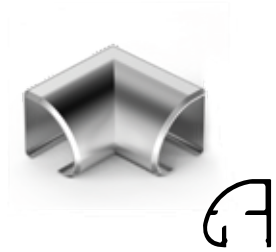

■ **330-502**
Elliptic Glass Holder Elbow 90°
Inner Channel



■ **330-504**
Elliptic Glass Holder Elbow 45°
Inner Channel



■ **330-601**
Elliptic Pipe Ring



■ **390-301**
Elliptic Pear Wall Flange

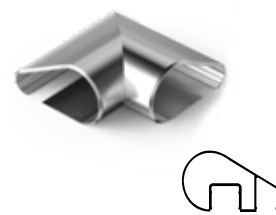

■ **390-505**
Elliptic Pear Elbow 90°
(Outside channel)



■ **390-506**
Elliptic Pear Elbow 45°
(Outside Channel)

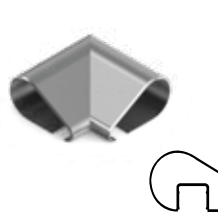

■ **390-509**
Elliptic Pear Elbow 90°
(Inside Channel)

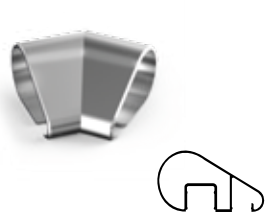

■ **390-510**
Elliptic Pear Elbow 45°
(Inside Channel)



■ **390-601**
Elliptic Pear Ring

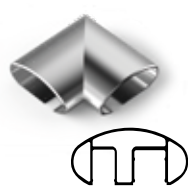

■ **380-513**
Elliptic 80x30 Elbow 90°
(Inside Channel)

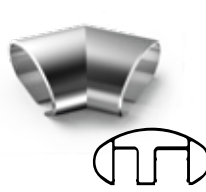

■ **380-514**
Elliptic 80x30 Elbow 45°
(Inside Channel)

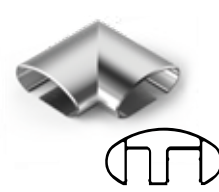

■ **380-515**
Elliptic 80x30 Elbow 90°
(Outside Channel)

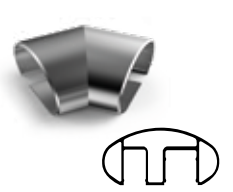

■ **380-516**
Elliptic 80x30 Elbow
45° (Outside Channel)

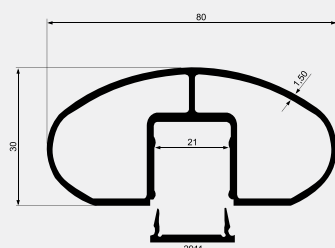

■ **08-080**
0.981 Kg/Mt

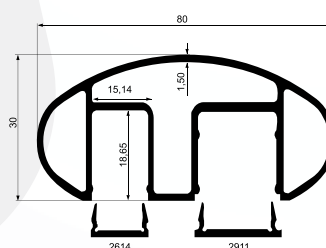

■ **08-079**
1.146 Kg/Mt

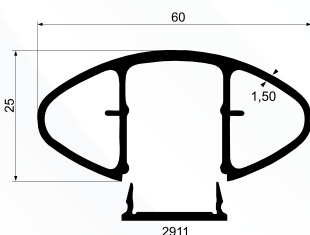

■ **08-078**
0.699 Kg/Mt

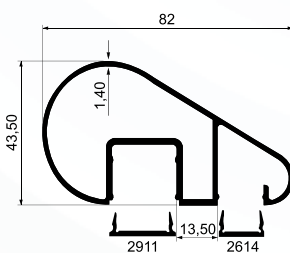

■ **08-081**
1.041 Kg/Mt

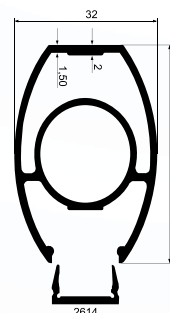

■ **08-085**
0.778 Kg/Mt

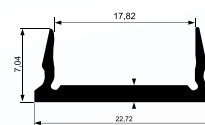

■ **2911**
0.119 Kg/Mt



■ **2614**
0.088 Kg/Mt

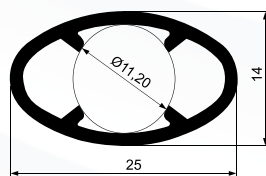

■ **08-082**
0.249 Kg/Mt

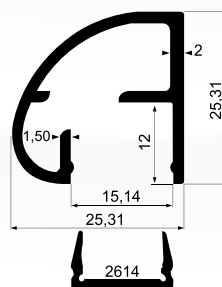

■ **08-083**
0.382 Kg/Mt

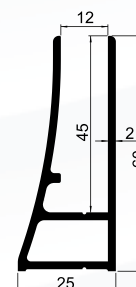

■ **2917**
0.892 Kg/Mt